

LED BATHROOM MIRROR INSTALLATION INSTRUCTION

(Suitable for the touch switch products installation by hanging bar or hardy hold)

FOR MODELS:

MLEC1818 # MLEC2424 # MLEC3030 # MLER1824 # MLER1830 # MLER2424
MLER2430 # MLER2448 # MLER2460 # MLER3030 # MLER3036 # MLER3060

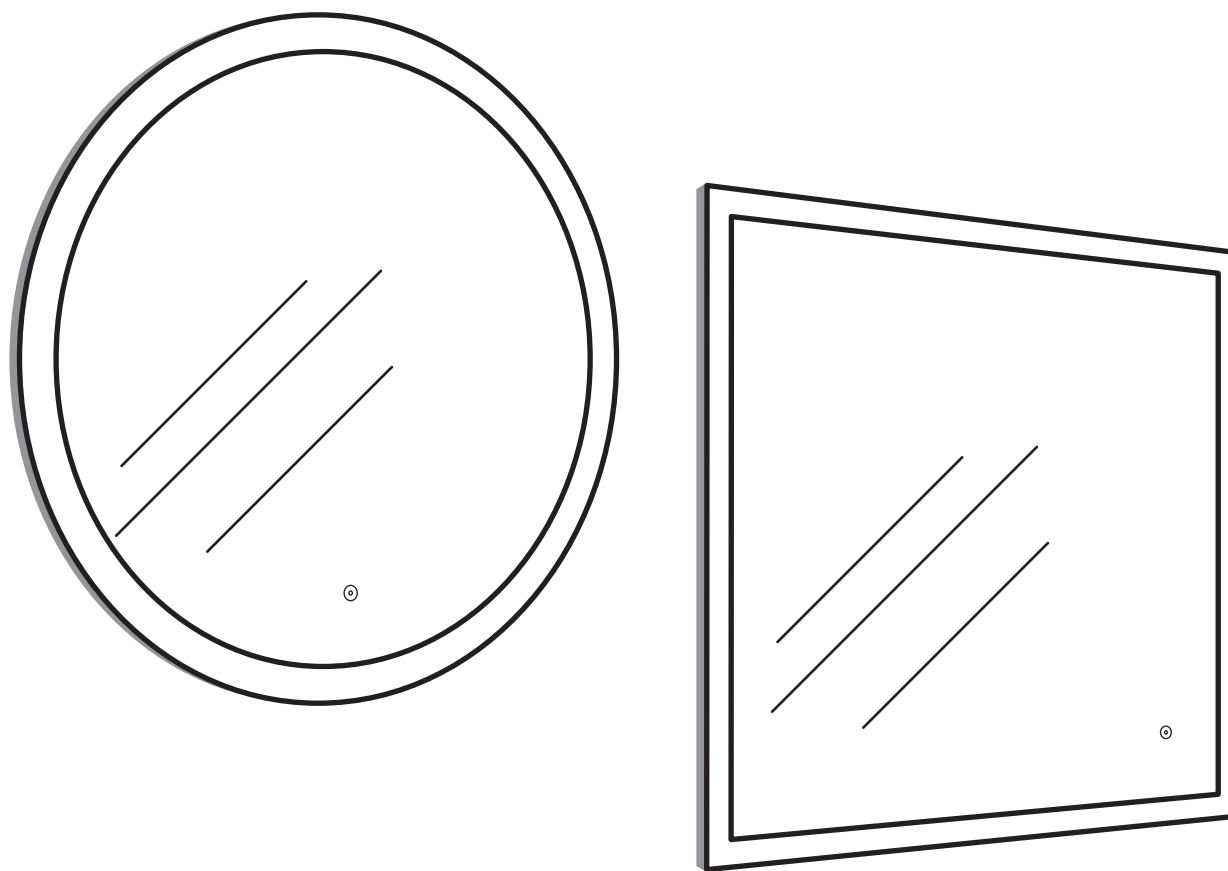

Notes: to ensure the normal use of products, it is required set out wires as per the regulations of IEE at the installation places. The products are only applicable to be installed on the indoor. The installation must be executed by a professional electrician, wrong installation may lead to product damage and personal injury.

A / Hanging bar Installation Manual (Instruction for LED bathroom mirror)

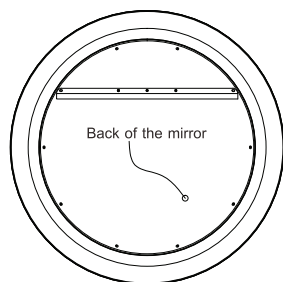

1. Please choose portrait or landscape installation method first.

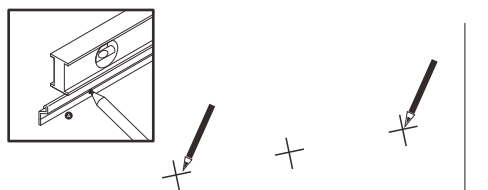

2. Horizontally level the hanging bar. Mark on the wall the hanging bar holes.

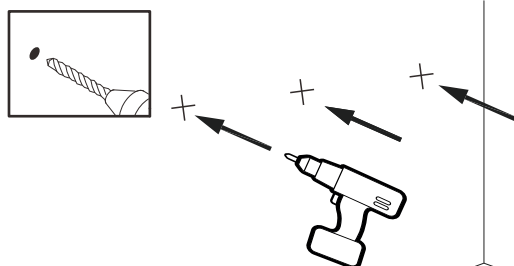

3. Drill the holes.

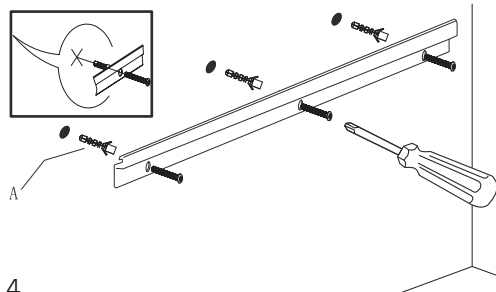

4. Install the expansion plug in to the holes, Screw the hanging bar to the wall tightly.



POWER OFF

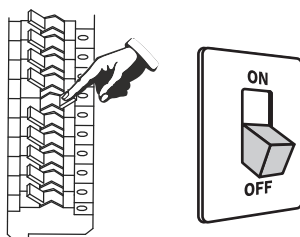

5. Cut off electric power before connection!

INPUT WIRING DIAGRAM

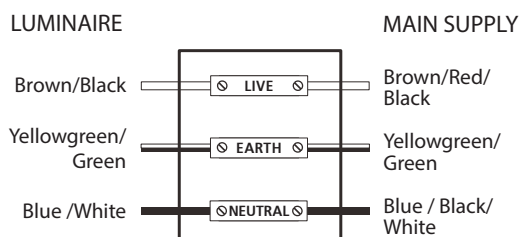

6. Connect as per above diagram.

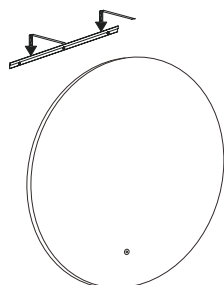

7. Hung up the mirror. Shake left and right to check stability.

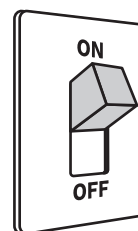

8. Turn on the power.

B / Hardy Holes Installation Manual (Instruction for LED bathroom mirror)

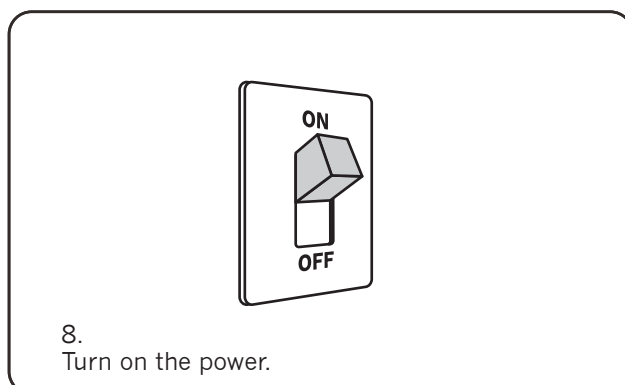
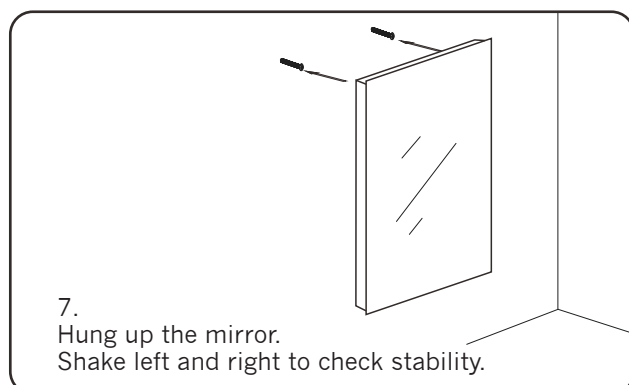
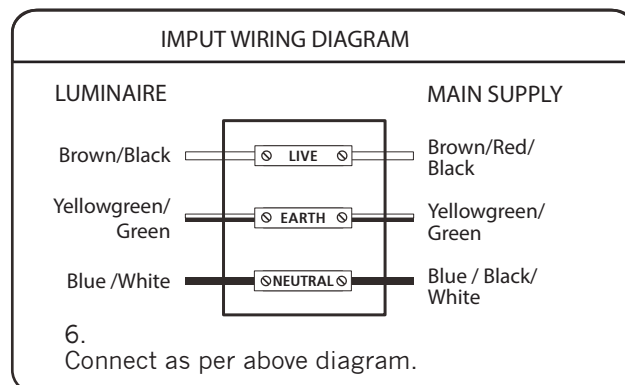
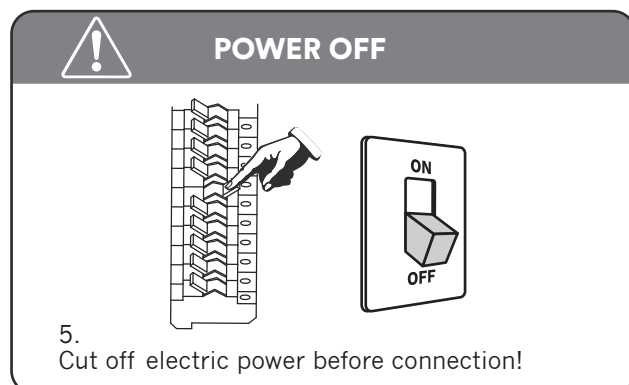
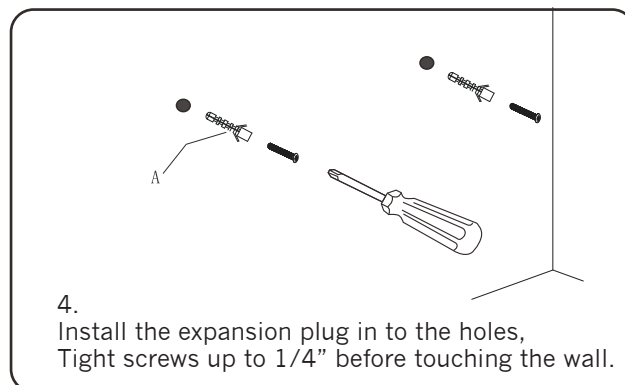
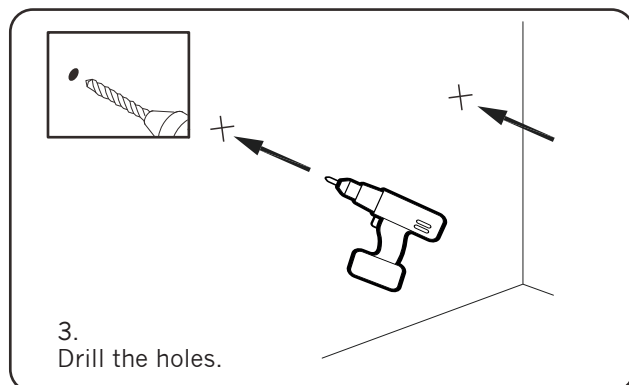
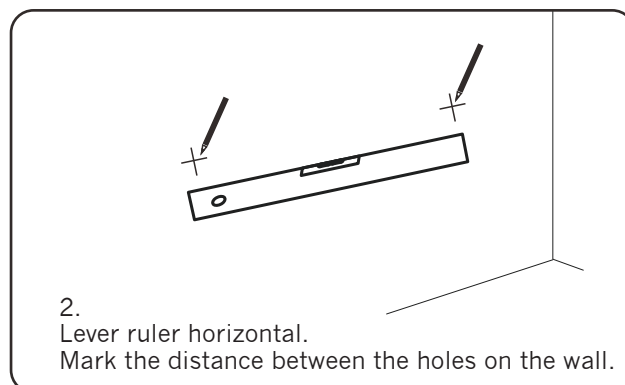
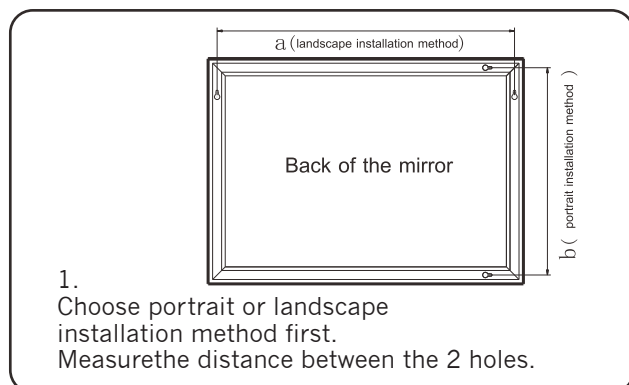

Function Usage



Touch switch, Press-hold for color change

Part List

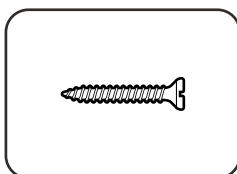

M4 SCREW

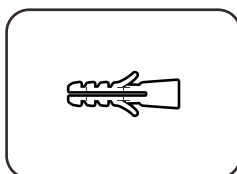

D6 EXPANSION PLUG

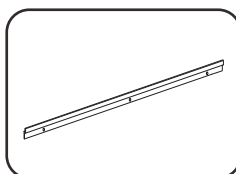

HANGING BAR

Installation Tools Needed

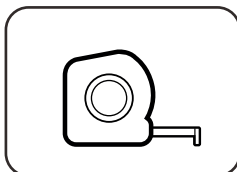

MEASURE TAPE

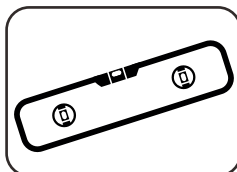

LEVEL

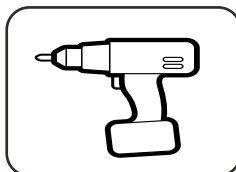

DRILL

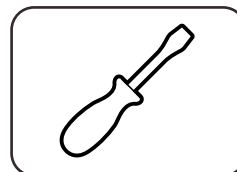

SCREWDRIVER

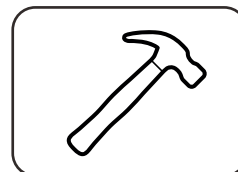

HAMMER

Notes: ⚠

1. Please do not use if the product have any lost or broken pieces.
2. During installation, never put sharp or pointy materials against mirror surface.
Otherwise it may result in leakage or personal injury.
3. DO NOT forget to turn off the power switch in storm days.
Otherwise lightning may damage electric elements of the product.
4. During operation, DO NOT pull out the power plug to stop the product.
Otherwise electric elements of the product may be damage.
5. Please pull out the power plug if the product won't be used for long time.
6. In case of functional failure of the product, user are not allowed to disassemble and repair without authorization.
Otherwise our company will not be responsible for any safety accidents.